

AirSafe

Continuous ambient air
dust monitoring



CONTENTS	Page
1. Introduction	3
1.1 Safety	3
1.2 Product overview	3
1.3 How the device works	3
1.4 System	4
1.5 Assembly and installation	4
2. Electrical connection	5
2.1 AirSafe acting as a limit value monitor with a relay output	5
2.2 Connection of DIN rail transmitter	5
2.3 DIN rail transmitter	6
3. Dimensions	7
3.1 Sensor	7
3.2 DIN rail transmitter	7
4. Operation	8
4.1 Alarm threshold	8
4.2 One-button operation	8
4.3 AutoSetup	9
4.4 DIN rail transmitter	9
4.5 PC software	10
5. Maintenance	12
6. Troubleshooting	12
6.1 Output relay fails to switch	12
6.2 Measured value not displayed even after AutoSetup	12
7. Technical data	13

1. Introduction

1.1 Safety

AirSafe requires a $24 \pm 10\%$ V DC supply. $24 \pm 10\%$ V DC is regarded as safe.

The DIN rail transmitter requires a $24 \pm 10\%$ V DC supply. $24 \pm 10\%$ V DC is regarded as safe.

1.2 Product overview

Thousands of triboelectric sensors from SWR have proven their worth for measuring dust concentrations in processing systems.

AirSafe is a measuring device which can monitor the dust concentration in the ambient air, for example in buildings, production halls, silos, boiler houses and at work stations.

AirSafe monitors on the basis of defined limit values.

For example to prevent the creation of dust explosion zones or to detect unnoticed dust emissions from system components.

Dust concentrations which may result in personnel being placed in danger can be detected early and reliably by AirSafe.

1.3 How the device works

AirSafe consists of a flow duct and an integral triboelectric dust sensor.

Drawing air into the flow duct generates an air flow of approx. $100 \text{ m}^3/\text{h}$.

Dust particles carried in this air flow which pass the sensor create a charge transfer which in turn generates a measurement signal.

The measurement signal is converted into an electrical signal which can then be displayed or output.

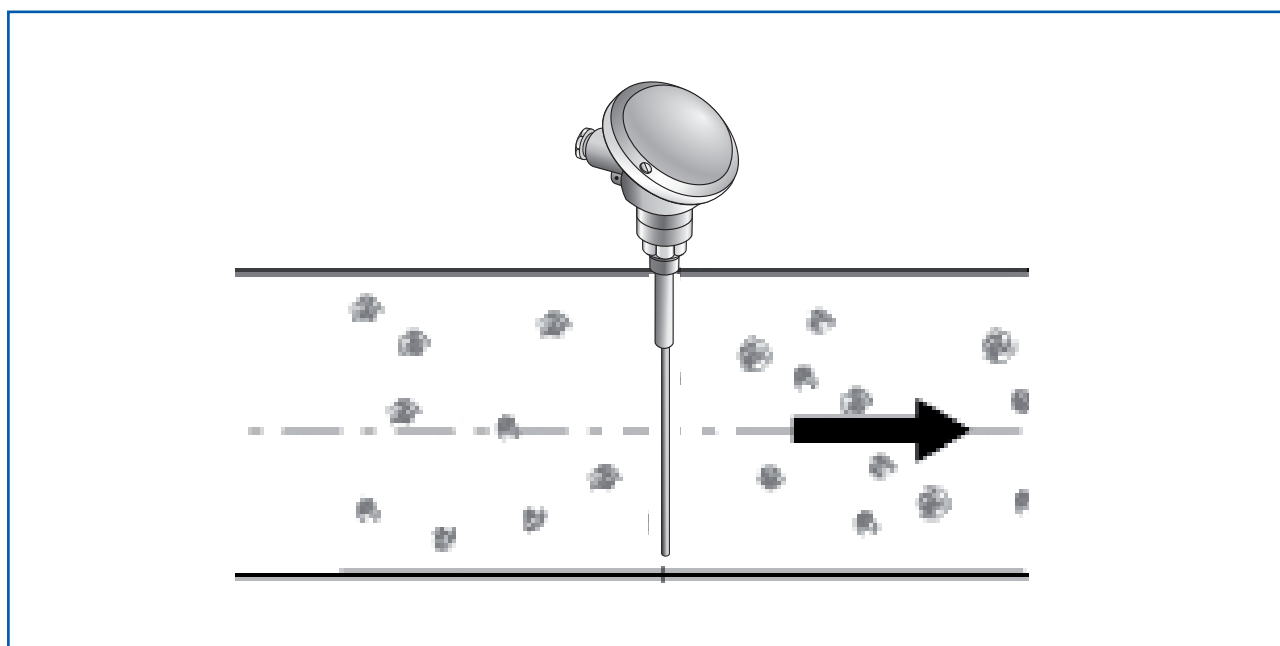

1.4 System

The AirSafe flow duct measures 500 mm in length and has a diameter of 100 x 100 mm.

The integral dust sensor has a relay output which switches or trips an alarm if a limit value specified by the customer is exceeded.

The sensor's measuring range is between 0.1 and 150 mg/m³. The device is supplied with a preset alarm threshold whose switching point is around 25 mg of dust* per m³.

* May be dependent on the dust type.

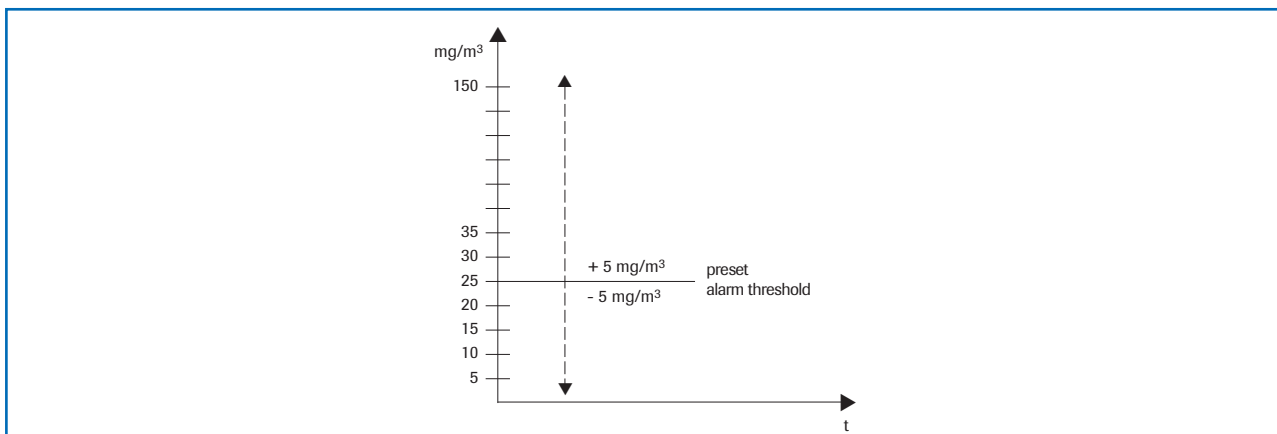

If required the measurement point can be extended with a measuring transducer to generate a continuous output signal (4 ... 20 mA).

The system can also be connected to a higher level computer using an RS 485 interface.

Measurements from up to 10 measurement points can be displayed and saved with the help of a visualisation software package. Stored measurements can be processed at any time using Excel, for example.

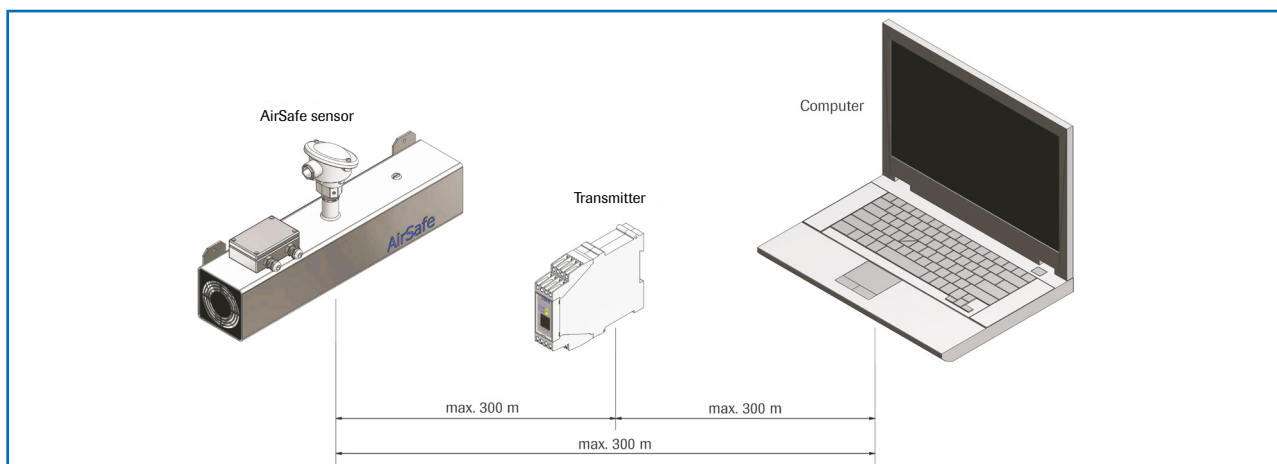

1.5 Assembly and installation

AirSafe can be positioned at any position within a room.

With the exception of excessive ambient temperatures (max. 60 °C) there is no need to position it at specific distances from units or walls.

The brackets provided for this purpose also allow AirSafe to be wall mounted.

2. Electrical connection

AirSafe has an internal connection chamber with plug-in contacts which can be cabled to suit the appropriate installation option:

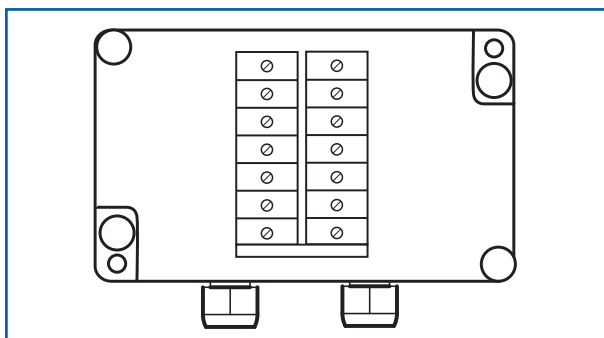

Plug No.	Signal
1	V+ (24 V DC)
2	V- (0 V)
3	RS 485 - A
4	RS 485 - B
5	Relay NO
6	Relay C
7	Relay NC

2.1 AirSafe acting as a limit value monitor with a relay output

The following contacts must be connected if AirSafe is used as a limit value monitor with a relay output:

Plug No.	Signal
1	V+ (24 V DC)
2	V- (0 V)
5	Relay NO
6	Relay C
7	Relay NC (alternative)

2.2 Connection of DIN rail transmitter

The retrofitting DIN rail transmitter can use the existing 4-core cabling but a different assignment of the connection terminals must be used in the sensor since digital communication cables are required.

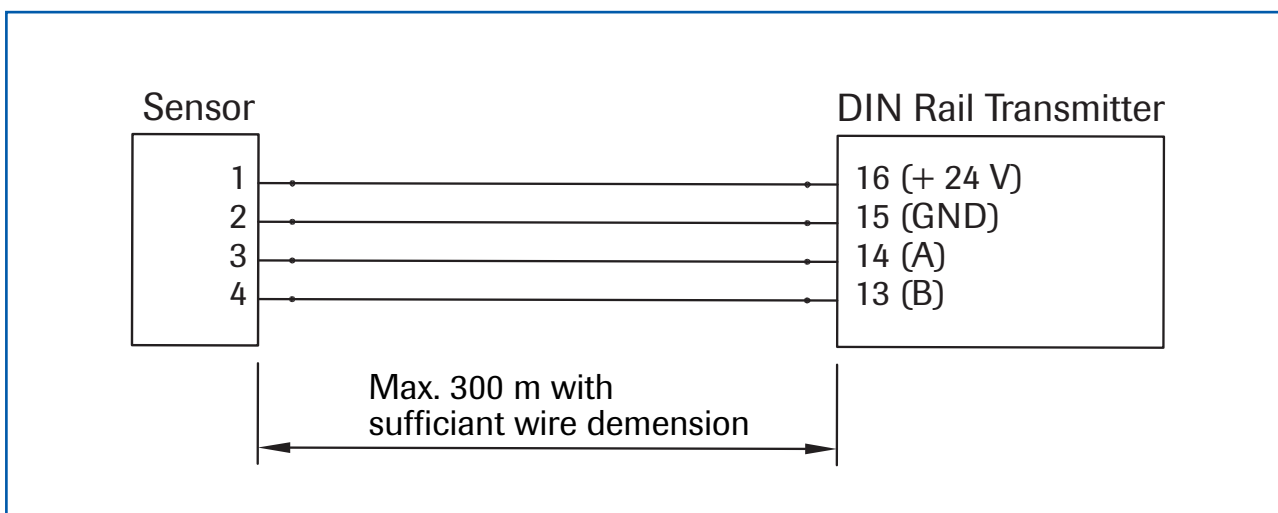

A shielded, twisted cable is recommended for long distances and environments with lots of interference sources.

2.3 DIN rail transmitter

1 Current output - 4 ... 20 mA	2 Current output + 4 ... 20 mA	3 Input Power supply 0 V DC	4 Input Power supply + 24 V DC
5 Not available	6 Alarm relay NC (break contact)	7 Alarm relay C	8 Alarm relay NO (make contact)

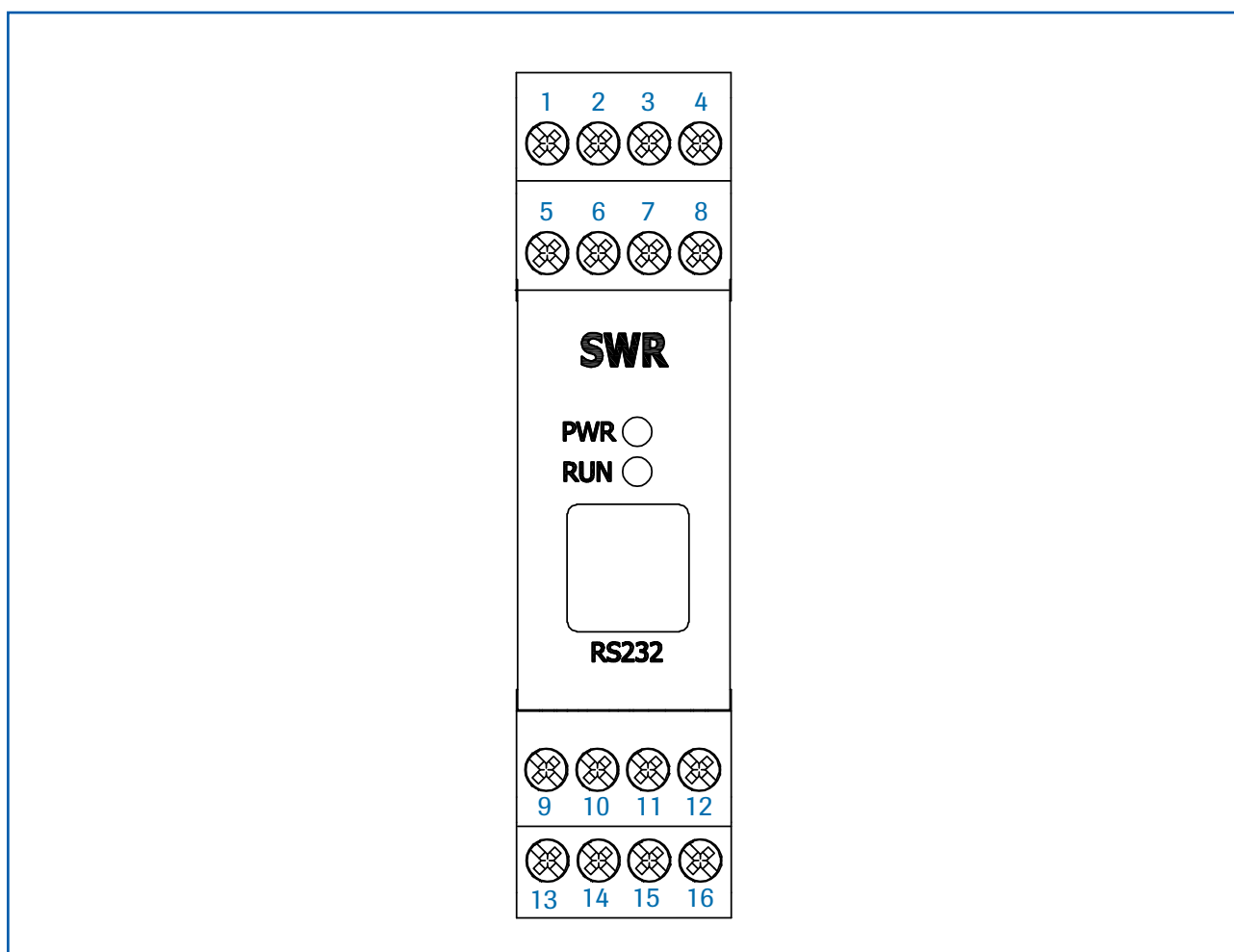

9 Not available	10 Not available	11 RS 485 Interface Data B	12 RS 485 Interface Data A
13 Sensor connection cable 4 RS 485 Data B	14 Sensor connection cable 3 RS 485 Data A	15 Sensor connection cable 2 Power supply 0 V	16 Sensor connection cable 1 Power supply + 24 V

3. Dimensions

3.1 Sensor

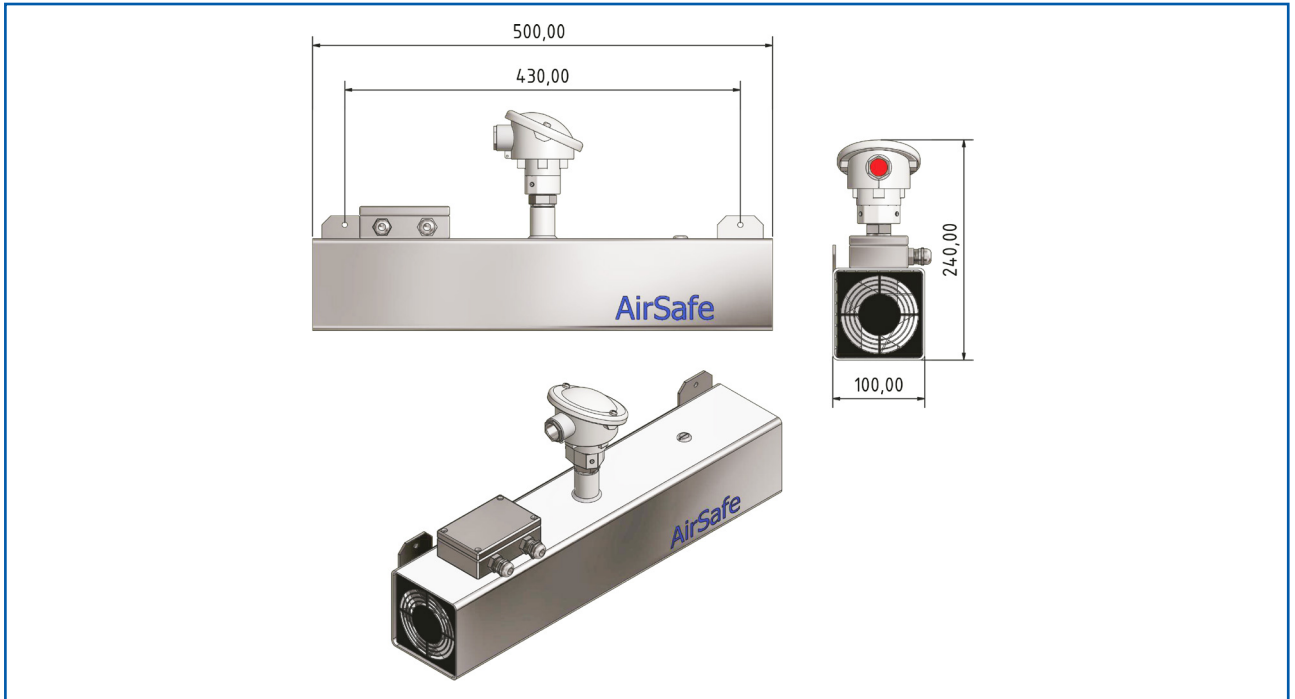

Fig. 1: AirSafe dimensions

3.2 DIN rail transmitter

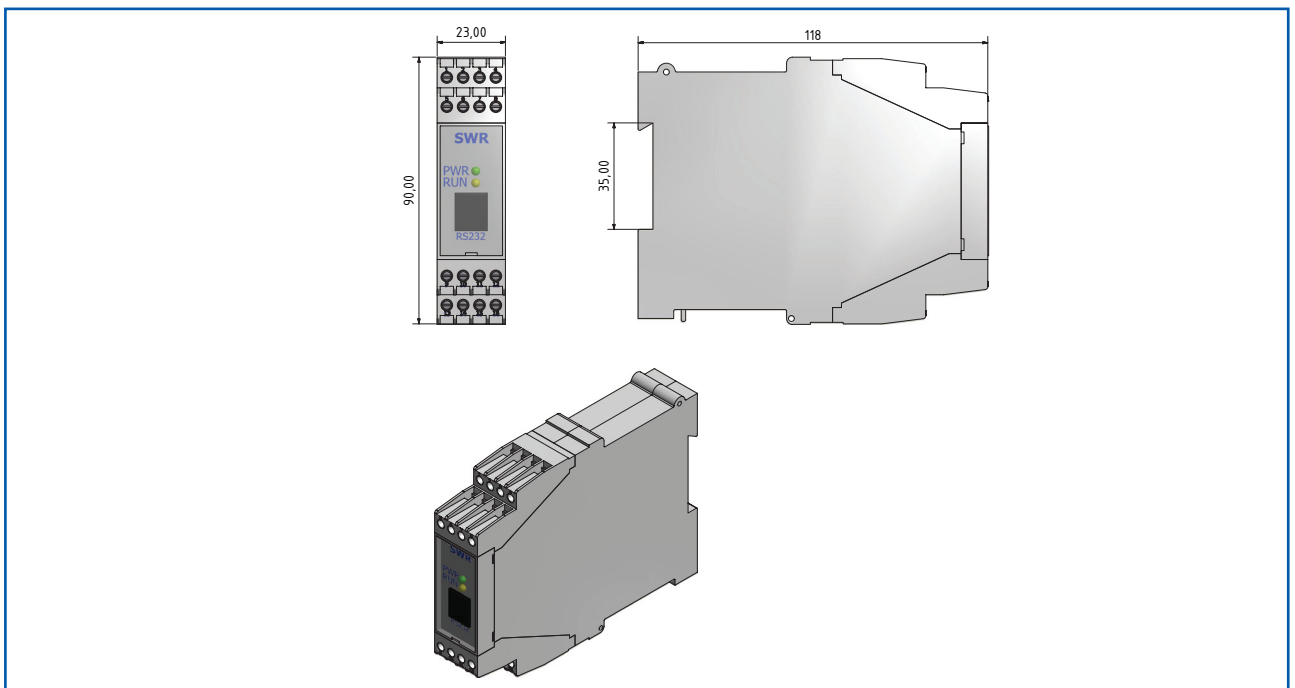

Fig. 2: DIN rail transmitter dimensions

4. Operation

AirSafe measures the dust content in a gas passing the sensor using the triboelectric principle by means of the exchange of charge carriers between the dust particles and the sensor.

When it is switched on the LEDs will flash to provide information about the sensor status: initially the red LED will flash during internal system checks. After this the yellow LED will flash to provide information on the set multiplier for the alarm threshold. After this the green LED indicates that it is measuring mode by a frequency which will increase as the dust content rises. The green LED will go out if the alarm threshold is reached or exceeded.

Measurements above the alarm level will be indicated by the yellow LED. At the same time the alarm output (relay) will switch.

The detection of an internal error will be indicated by the red LED flashing whilst the sensor is in measuring mode.

4.1 Alarm threshold

The alarm threshold is set at the factory to a dust content of approx. 25 mg/m³ with organic material in a gas velocity of approx. 10 m/s.

This dust concentration corresponds to a reference measurement in the dust duct and is not an absolute reference for the customer's material or the flow conditions.

To adjust the sensor to the conditions in which it is installed, AirSafe has a multiplier using which the alarm threshold can be moved upwards or downwards.

- The **internal measurement level** is fixed in a reference measurement to approx. 5 mg/m³.
- The multiplier is fixed at a value of 5.
- The **alarm threshold** is calculated from **[Multiplier * Internal measurement level] = [5*5 mg/m³]**.
- **Alarm threshold = 25 mg/m³.**
- Changing the **multiplier to 4** means that the **alarm threshold is changed to = 4*5 mg/m³ = 20 mg/m³.**
- Changing the **multiplier to 10** means that the **alarm threshold is changed to = 10*5 mg/m³ = 50 mg/m³.**
- Changing the **multiplier to 30** means that the **alarm threshold is changed to = 30*5 mg/m³ = 150 mg/m³.**

Higher dust concentrations can be set using an AutoSetup function.

4.2 "One-button operation"

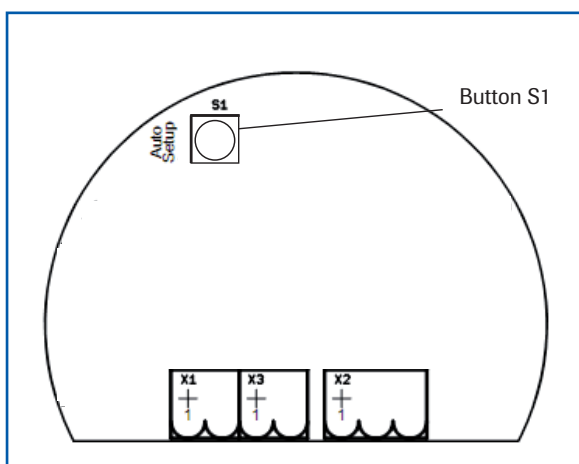

Pressing S1 starts a sequence of flashing signals on the LEDs. To start a specific function the button must be released when the required function is indicated by the flashing pattern.

1. Command sequence: for information only.

Initially all three LEDs will flash together up to 5 times. If you release S1 during this sequence the activation procedure will be repeated, in other words the red LED will flash twice during the internal function tests and the yellow LED will flash to indicate the current multiplier.

2. Command sequence: change the multiplier.

If you continue to hold S1 beyond the first sequence, the yellow LED will start to flash. If you release S1 the number of flashes by the yellow LED will determine the value of the multiplier. The yellow LED will flash a maximum of 30 times.

3. Command sequence: AutoSetup!

If you continue to hold S1 a countdown will start on all 3 LEDs. After this all three LEDs will flash up to 5 times. The AutoSetup function will start if you release S1 whilst they are flashing together. (See section 4.3)

4. Command sequence: restore factory settings.

If you continue to hold S1 a new countdown will show the last sequence: The three LEDs will flash together again up to 5 times. If you release S1 during this the factory settings will be restored.

The LEDs will go out after the last sequence until S1 is released again. In this case no changes will be made.

4.3 AutoSetup

Use the AutoSetup function to set an individual alarm threshold. AutoSetup considers the current dust content in the duct and saves this as the internal measurement level multiplied by the current multiplier as the new alarm threshold. (See section 4.1)

To use the AutoSetup function successfully the process should be carried out with a uniform dust content and the device should be operated for at least 10 minutes. The AutoSetup function is started by pressing S1. (See section 4.2)

The LEDs flash during AutoSetup to act as chaser lights and the sensor then measures the dust content in the duct. The sensor saves the peak values from the measurement which occur during AutoSetup.

The highest peak value (after internal measurement filtration) is used to calculate the internal measurement level and used with the set multiplier to calculate a new alarm threshold.

The AutoSetup function takes 5 minutes. After it the new alarm threshold is saved, the LEDs go out and the green LED starts to flash again at a frequency which corresponds to the ratio of the dust content to the alarm threshold, thus indicating it is ready for use.

The AutoSetup function can be cancelled by pressing S1. This results in no parameters being saved or changed.

4.4 DIN rail transmitter

The DIN rail transmitter communicates with the sensor using a digital protocol. No alternative cabling is required for this purposes between the transmitter and the sensor.

Once it has been connected the DIN rail transmitter takes the alarm threshold saved in the sensor as the 12 mA point and the measurement of zero as the 4 mA point to define a linear transfer characteristic curve from the current measurement to the current output. No parameters are saved in the DIN rail transmitter and it does not require any type of commissioning.

If the alarm threshold is changed by AutoSetup, the gradient for the transfer characteristic curve is adjusted automatically.

The DIN rail transmitter's relay output has exactly the same properties as the sensor's relay output.

It is possible to communication with the sensor via the DIN rail transmitter using simple user software so as to adjust the sensor in the event that it is difficult to access due to its installation situation.

4.5 PC software

If the DIN rail transmitter is used, it is possible to access the sensor using simple user software to define the function of the relay and to mirror the functions of S1.

This software has been kept very simple and is almost self-explanatory.

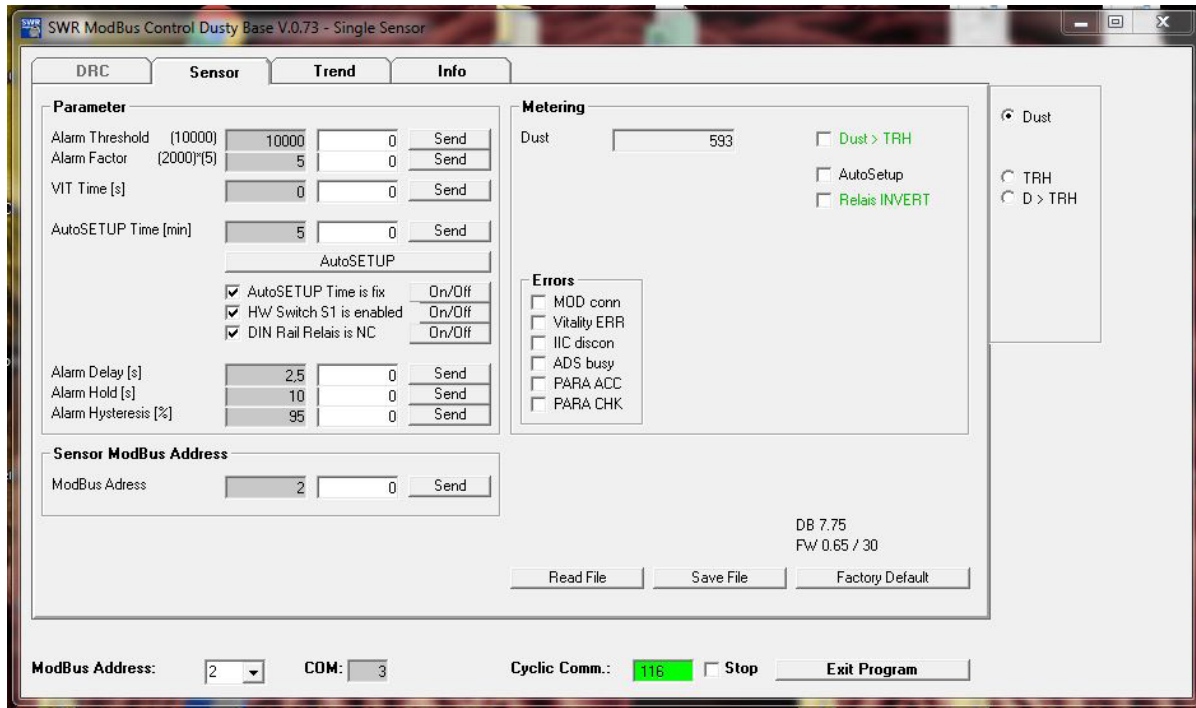

The alarm threshold and the multiplier can be changed and the duration of the AutoSetup can be adjusted. However, this overwrites the factory settings.



The AutoSetup function can be started using the "FindTRH" button.

The following functions can be enabled and disabled using the appropriate "ON/OFF" buttons.

- **Fix AS Time:** If enabled, AutoSetup will be run for the set time. If disabled the AutoSetup will be extended each time by the set time when a new peak value is found.
- **S1Active:** If enabled, the S1 key can be evaluated by the sensor. If disabled the key is not evaluated to prevent unauthorised use.
- **DIN Rail Relay NC:** If enabled the DIN rail transmitter relay acts as a break contact (NC - normally closed), if disabled it acts as a make contact (NO - normally open).

In addition the software provides information on the sensor's serial number, the DB and FW version of the sensor and displays the measurement and the status of the alarm outputs (Dust > TRH) and indicates whether the AutoSetup function is running.

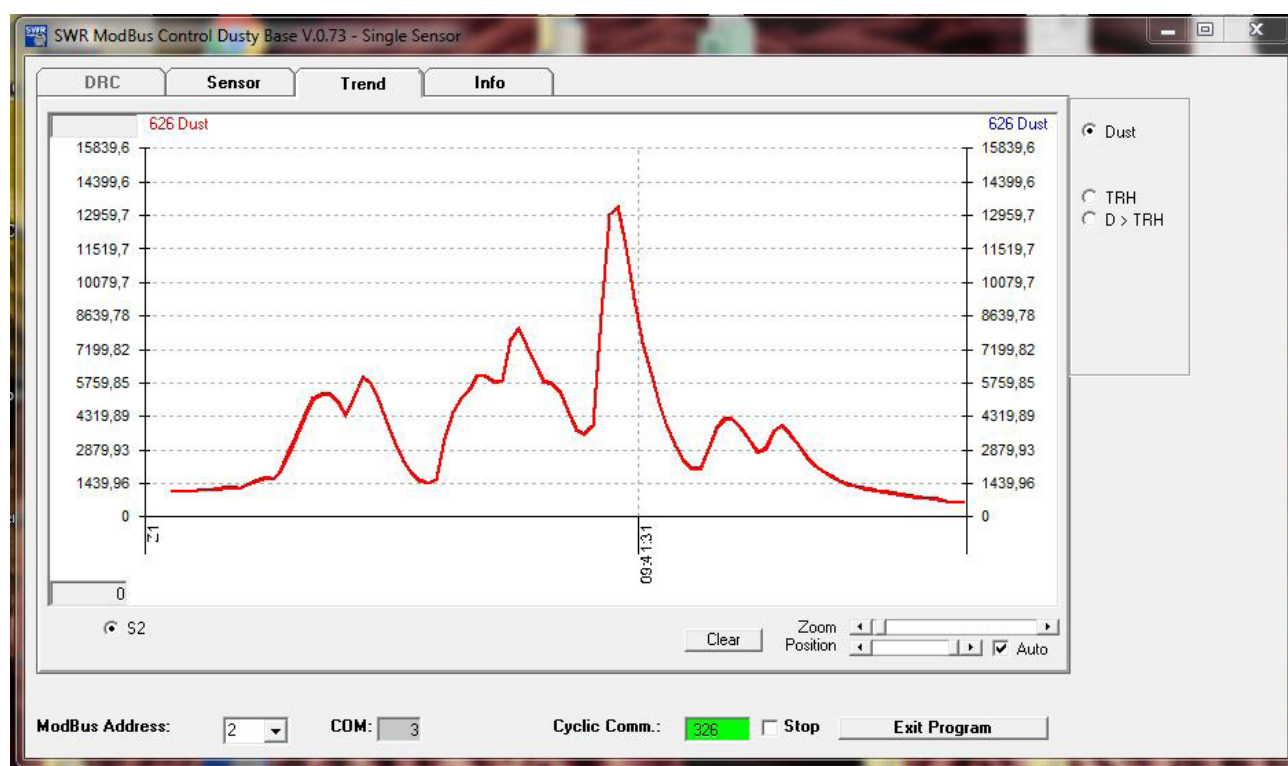

The current measurement can be displayed in a trend window together with the alarm threshold and, possibly, the status of the relay.

5. Maintenance

Maintenance work is restricted to removing the sensor from the channel now and again and cleaning any accumulated particles off the probe and the insulation section using a cloth.

This is designed to prevent accumulated material resulting in bridge formation against the earthed environment since this has a significantly adverse effect on the measurement. The other aim is to prevent the probe becoming encased with accumulated material.

No maintenance work is required in the sensor housing or on the field electronics.

6. Troubleshooting

6.1 Output relay fails to switch

1. Check power supply and the connection contacts.
2. Check whether the green LED is flashing or the yellow LED is lit. This indicates a problem with the relay contact.
3. Check whether the red LED flashes during an active measurement. Error code!!

If the sensor is still not supplying signals after these checked, contact our agents or SWR engineering Messtechnik GmbH direct.

6.2 Measured value not displayed even after AutoSetup

1. Check whether the process is running normally and whether the conditions were normal during the AutoSetup procedure.
2. Check the flashing frequency of the green LED and status of the yellow LED.
3. Check the power supply and the cabling.
4. Check for bridge formation and short circuit.
 - Contact between probe and duct wall?
 - Bridge formation between probe and duct?
 - Casing formation around the probe due to condensate?

These instruments conform to the following standards:

	Product standard - electrical equipment for measurement, control and laboratory use EMC requirement
	Reference standard EN 661326
	Year of publication (1997) Updates A1 (1998), A2 (2001), A3 (2003)

7. Technical data

AirSafe dust detector	
Measured objects	Solid particles in a stream of gas
Particle size	0.3 µm or larger
Measurement range	From 0.1 mg/m ³
Ambient temperature	- 20 ... + 60 °C
Humidity	95 % RH (non-condensing)
Measurement principle	Triboelectric
Damping time	1 s
Output signals	Relay output, either NC or NO
Dimensions	500 x 100 x 240 (L x W x H)
Housing material	Sensor: Aluminium Flow duct: St52 powder-coated
Power supply	24 ± 10 % V DC
Rating	Max. 10 W
Electrical connection	Screw terminals
Weight	5.5 kg
Transmitter (DIN rail)	
Power supply	24 ± 10 % V DC
Power consumption	20 W / 24 VA
Protection type	IP 40 to EN 60529
Ambient operating temperature	-10 ... +45 °C
Dimensions	23 x 90 x 118 (W x H x D)
Weight	Approx. 172 g
Interface	RS 485
Connection terminals conductor cross-section	0.2 - 2.5 mm ² [AWG 24-14]
Current output signal	4 ... 20 mA (0 ... 20 mA), load < 500 Ω
Switch output measurement alarm	Relay with switchover contact - Max. 250 V AC, 1 A
Interface	ModBus (RS 485)
Data backup	Flash memory