

UPS Uninterruptible Power Supply MTD 700 / 1000 / 1500 / 2000 / 3000

Operating Manual V. 3.1



Article number:	Tower housing
MTD 700:	ACX 11MSS70000000
MTD 1000:	ACX 11MSS1K000000
MTD 1500:	ACX 11MSS1K500000
MTD 2000:	ACX 11MSS2K000000
MTD 3000:	ACX 11MSS3K000000
	19 " Rack mountable
MTD 700RM:	ACX 11MSR70000000
MTD 1000RM:	ACX 11MSR1K000000
MTD 1500RM:	ACX 11MSR1K500000
MTD 2000RM:	ACX 11MSR2K000000
MTD 3000RM:	ACX 11MSR3K000000

Legal Notice



© by EFFEKTA Regeltechnik GmbH

EFFEKTA Regeltechnik GmbH, 78628 Rottweil, retains the copyright to this documentation.

This documentation is solely intended for the operator and his staff. The content of this documentation (texts, figures, drawings, graphics, plans, etc.) may not be copied or distributed in part or in full without our consent in writing, nor can it be used without authorisation for competitive purposes or given or made accessible to third parties.

EFFEKTA Regeltechnik GmbH

Rheinwaldstraße 34
D – 78628 Rottweil

Phone: + 49 (0) 74 1 / /1 74 51 - 0
Fax: + 49 (0) 74 1 / /1 74 51 - 22
E-mail: ups@effekta.com
Internet: www.effekta.com

Manual: Operating manual
Language: English
Release date: 03/2012

We reserve the right to make changes to the design and the system that will improve the system, the production process or the product.

Table of Contents

- 1. Introduction 5**
- 1.1 Foreword 5
- 1.2 Validity 6
- 1.3 Storage 6
- 1.4 Symbols in this Manual..... 6
- 1.5 Information Obligation10
- 1.6 Warranty Conditions.....10
- 1.7 Transport and Storage.....12
- 1.8 Positioning.....13
- 2. Safety Instructions14**
- 2.1 Introduction14
- 2.2 Proper Use14
- 2.3 Avoiding Personal Injury / Property Damage15
- 2.4 Protecting the Environment15
- 2.5 Connection16
- 2.6 Operation17
- 2.7 Handling Accumulators.....17
- 2.8 Maintenance, Service and Malfunctions18
- 3. Device Description of UPS.....19**
- 3.1 Device Elements on the Front20
- 3.2 Device Elements on the Back26
- 3.3 Acoustic Warnings of the UPS.....34
- 4. Storage and Unpacking35**
- 4.1 Storage of the UPS35
- 4.2 Unpacking the Device.....35
- 5. System Description36**
- 6. Installation and Connection of the UPS37**
- 6.1 Connection of the UPS37
- 6.2 Communication Connection of the UPS.....38
- 6.3 Connection Sequence39
- 7. The Device and its Operation40**
- 7.1 Operating the UPS40
- 7.2 Operating Manual for the UPS.....45

8.	Starting up the UPS System	49
9.	Eliminating Errors	50
10.	Software	52
11.	Maintenance and Service	53
11.1	Measurement of the Bridging Period (Support Period)	53
11.2	Replacing the Accumulators	54
11.3	Service Report.....	55
11.4	Service Hotline.....	56
11.5	Maintenance and Service Contracts.....	56
12.	Technical Data	57
12.1	Device Specifications for Tower Housing	57
12.2	Device Specifications for Rack Mountable	59
12.3	Scope of Delivery / (Optional) Accessories	61
12.4	Wear Parts List	63
13.	Requirements from the Declaration of Conformity	64

1. Introduction

1.1 Foreword

Dear Operator,

You are about to operate an uninterruptible power supply.

This operating manual should provide you with support for working responsibly and give you basic information about the uninterruptible power supply, namely how it operates, its application and what you should do in the event of malfunctioning. Furthermore, this operating manual contains instructions for the transport and storage as well as the handling and installation of the uninterruptible power supply.

The plan guidelines in this operating manual only relate to special requirements for the uninterruptible power supply. During installation, make sure you follow the national and local requirements for electrical installations.

The content of this device description may change due to technological progress. We have tried to present the content correctly and clearly. If, however, we have made errors, we would be grateful for information about this.

We are not liable for errors in this operating manual and the resulting consequences.

The uninterruptible power supply is intended to protect sensitive, electrical systems against interruptions that can occur due to poor power quality or mains failures.

Please read this operating manual carefully and regard in particular the safety instructions!

If you have questions about the device, our technical supervisor or our employees will be glad to help you.

Your
EFFEKTA Regeltechnik GmbH

1.2 Validity

The descriptions in this operating manual relate solely to the uninterruptible power supply defined in the

Technical Data

as a whole or they refer to modules, components and individual parts that were developed and built by **EFFEKTA Regeltechnik GmbH**.

★ 12. Technical Data



1.3 Storage

This operating manual for the device must be stored in the vicinity of the device at all times so it is immediately available if need be.

1.4 Symbols in this Manual

The abbreviation UPS in this manual stands for the uninterruptible power supply.

- Read this documentation carefully and make yourself familiar with the product before using it.
- Store this operating manual in an easily accessible place to refer to it if necessary.
- Please pass this operating manual on to later users of the product.

1.4.1 Danger warning levels

DANGER!



Text that is marked with **DANGER!** provides a warning about dangers. If accident prevention measures are not taken, these dangers may result in serious (irreversible) injuries or even death!

WARNING!



Text that is marked with **WARNING!** provides a warning about hazards. If accident prevention measures are not taken, these hazards may result in serious (irreversible) injuries or even death!

CAUTION!



Text that is marked with **CAUTION!** provides a warning about hazards. If accident prevention measures are not taken, these dangerous situations can lead to slight or medium reversible injuries.

ATTENTION!

Text that is marked with **ATTENTION!** contains very important instructions for situations that, if accident prevention measures are not taken, may result in damage to the product and / or its functions or an object in its vicinity.



This symbol indicates text that contains important instructions / comments or tips.

1.4.2 Warning information

1.4.2.1 Warning about danger spots



General warning about danger spots!

1.4.2.2 Specific warning



Warning about dangerous electrical voltage!



Warning for handling accumulators!

1.4.3 Instruction symbols



Regard the provided documentation and/or instructions!



Disconnect before work!

1.4.4 General symbols

- This dot marks descriptions of activities that you should carry out.
- This dash marks specifications.
- ★ This arrow marks a cross reference.
 If a cross reference to another chapter is necessary in the text, this is shortened for clarity.
 Example: **★ OM, 2 Safety Instructions**
 This means: See chapter 2 Safety Instructions.
 If the cross reference refers to a page, figure or position number, this information is added at the end of the cross reference.
 Example: **★ Fig. 4 - 4, Pos. 1**
 This means: See position number 1 in figure 4 (in chapter 4 of this manual).

(3) Numbers in brackets refer to the positions in the figures.



Identifies instructions for recycling.



Identifies components that are subject to the Electronic Scrap Regulation.



Identifies components or parts that must be disposed. Do not throw these in the household waste.



Requirement that must be fulfilled:
 ✓The DC circuit breaker is on "OFF."

1.5 Information Obligation

This operating manual must be read, understood and all its points regarded by all persons that are responsible for the

- operation
- cleaning and
- disposal

of the device.

EFFEKTA Regeltechnik GmbH is not liable for damage incurred or caused by not or insufficiently trained staff!

1.6 Warranty Conditions

The receipt of delivery is considered as the record for the initial purchase and should be stored in a good place. It will be necessary for making use of the warranty. If the product is passed on to another user, he has the right to the warranty for the remainder of the warranty period. The purchase receipt as well as this declaration should also be given to the new owner if the device is passed on.

We guarantee that this device, upon delivery, is in a functional state and technically conforms to the descriptions in the appended documentation.

The warranty period for special devices corresponds to the minimum periods stipulated by law.

The warranty ceases to apply in the following cases:

In the event of defects from: freight damage, accident, natural catastrophes, misuse, vandalism, improper use, defective maintenance or incorrect repair by third parties.

- In the event of changes, unauthorised intervention, incorrect operation, another device or accessories, false installation or other modifications not approved by us.
- Improper use such as plugging the device into unsuitable energy sources, attempts to overload the UPS, use in an unsuitable environment, etc.
- In the event of failure to follow instructions in the provided documentation.
- In the event that the product is incompatible due to possible technical innovations or regulations that occur after the purchase.

- In the event of incompatibility or malfunctioning that was caused by product components we did not install.
- In the event of developments that are related to the normal aging process of the product (wear parts).
- In the event of defects that were caused by external fixtures.

The warranty period for replaced and/or repaired parts as part of this warranty expires together with the original warranty for the product.

Devices that are sent in without accessories are replaced without accessories. The return of the device is only accepted if this is done in the original packaging.

Incurred transport costs are generally not included in the warranty.

You shall bear the cost of repair and exchange, and the company is not liable for damage, whether directly, unintentionally, specifically, or for subsequent damage, even if it was caused by negligence or other errors.

EFFEKTA Regeltechnik GmbH does not provide either explicit or implicit warranties related to this device and its quality, performance, saleability or suitability for a certain purpose. In some countries, the exclusion of implicit warranties is not permitted by law. In this case, the validity of all explicit and implicit warranties is limited to the warranty period. With the expiration of these periods, all warranties lose their validity. In some countries, a limitation of the validity period of implicit warranties is not permitted by law so that the aforementioned limitation does not take effect.

1.6.1 Limitation of Liability

Claims to damage compensation are excluded unless they involve intent or gross negligence by **EFFEKTA Regeltechnik GmbH** or its employees. This does not affect liability according to the Product Liability Act. Under no circumstances are we liable for:

- claims that third parties make against you due to losses or damage.
- loss of or damage to your drawings or data or the costs of recovering this data.
- economic subsequent damage (including lost profits or savings) or concomitant damage, including in the event that we were informed of the possibility of such damage.

Under no circumstances is **EFFEKTA Regeltechnik GmbH** responsible for any accidental, indirect, specific, subsequent or other damage of any kind (including, without any limitation, damage related to a loss of profits, interruption of business, loss of business information, or any other losses) that results from use of the device or is connected with the device whether it is based on the contract, damage compensation, negligence, strict liability or other claims, even if **EFFEKTA Regeltechnik GmbH** was informed about the possibility of such damage in advance. This exemption also includes any liability that can result from the claims of third parties against the initial purchaser.

In some countries, the exemption or the limitation of concomitant or subsequent damage is not permitted by law so that the aforementioned declaration does not enter into force.

1.7 Transport and Storage

The UPS may only be transported to the intended location in the original packaging. The same applies to moves or returns.

The packaging plays no role as fall protection, so all fallen devices must be checked by **EFFEKTA Regeltechnik GmbH** before commissioning.

The device may not be transported or stored on its head.

1.8 Positioning

WARNING!



Do not install in an area in which combustible vapours result e.g. from petrol tanks, engine compartments, etc.

The UPS is designed for operation in ventilated rooms with a surrounding temperature of 0 ° to 40 °C.

If the UPS is exposed to severe and quick temperature changes, there is danger of condensation. Before you take additional steps, an acclimatisation period of at least 2 hours is to be observed.

Never place or operate the device in a moist environment. Keep liquids away from the device.

The UPS may not be placed in the vicinity of heat sources.

It is to be placed in a horizontal position.

Ensure that the rear side and the front side of the device are at least 10 cm from other objects for ventilation in order to prevent trapped air and too much warming. Ensure that the air openings cannot be covered, e.g. through drawn-in paper, fabric, etc.

2. Safety Instructions

2.1 Introduction



The UPS is a device produced for uninterruptible power supply in accordance with the technology rules and requirements.

The device and its related components, modules and parts meet individually and in their entirety the currently valid safety standards as well as the standards of the EC Machinery Directive 2006/42/EC.

The device is safe when used properly and under consideration of the safety requirements and instructions provided in this operating manual.

2.2 Proper Use



The UPS and its related components may only be used for purposes in accordance with its design - for the short-term supply of electrical devices (230 V AC) that do not exceed the nominal performance in its entirety.

Any other use is considered improper and can lead to personal injury or damage to the device!

Improper use:

The device is not designed for use

- in explosive,
 - dusty,
 - radioactive or
 - biologically or chemically contaminated atmospheres!
-

ATTENTION!

This is class A equipment. This equipment can cause radio interference in residential areas. In this case, operator may be requested to pursue appropriate measures!

2.3 Avoiding Personal Injury / Property Damage

- Please read this operating manual carefully to familiarise yourself with the device.
- In particular, heed the information regarding the installation and commissioning of the device.
- Only operate the product in an appropriate and proper way and within the parameters stated in the Technical Data.
- Only perform maintenance and service work that is described in the documentation. Observe the required steps. Only use original replacement parts from **EFFEKTA Regeltechnik GmbH**.

2.4 Protecting the Environment

- Send the product back to **EFFEKTA Regeltechnik GmbH** after the end of its use. We will ensure environmentally friendly disposal.

2.5 Connection

DANGER!



Only connect the UPS to an earthed electric safety socket or be sure to connect it to the protective conductor in the event of a connecting terminal. Under no circumstances may the device be operated without a protective conductor.



The socket for home installation must be easily accessible and in the vicinity of the UPS. Be sure to have the shortest possible cable lengths for fixed connections.



When operating with a generator, you must ensure the correct polarity of the connection for the UPS.

To connect the UPS to the socket of the home installation, only use a VDE tested and CE labelled mains cable. For a fixed connection, an appropriate cable is to be used.

To connect the loads to the UPS, only use a VDE-tested and CE-labelled cable. For a permanent connection of the loads, an appropriate cable is to be used.

The protection of the loads must always take place directly on a load, never centrally at the UPS.

Do not operate any household or craftsman tools such as fan heaters, vacuum cleaners, drills, hair dryers, toasters, etc. with the UPS.

Do not connect any loads to the UPS, which could overload the device (e.g. laser printer).

The total earth leakage currents of all the loads connected to the UPS may not exceed 3.5 mA.

Keep cables as short as possible and always lay them correctly. Dangers such as stumbling, squeezing, clipping, etc. are to be avoided with the cables.

To connect the loads to the UPS, only use a VDE-tested and CE-labelled power cables with the appropriate cable diameter. The protection of the loads must always take place directly on a load, never centrally at the UPS. Do not connect any loads to the UPS, which could overload the device (regard the high starting currents).

2.6 Operation

Before the loads are connected on the output, the basic configuration must be set. The output voltage in relation to the loads is Very Important.

The UPS system includes energy storage (accumulators). As a result, the output can carry power even if the UPS is not connected on the mains input side.

To completely switch off the UPS, disconnect the mains connector and then press the "OFF" key for more than 3 seconds, wait until the UPS is switched off and then disconnect the mains connection (remove the mains power cable from the device). Make sure that no liquids or foreign bodies enter the UPS. To protect the UPS, you should avoid a constant load at the output of over 80 %. The display of the output load is only to be viewed as a reference value. To determine the exact output load, separate measurements are required.

2.7 Handling Accumulators

DANGER!



Attention – Danger of electric shocks and burns.

Accumulators can cause electric shocks and produce high short circuit currents that can in turn lead to burns.



Unauthorised staff are to stay away from accumulators.

Do not bring accumulators into contact with heat sources or throw them in the fire. There is an explosion danger!

Do not open or destroy accumulators. The released electrolyte is very dangerous for people and the environment (searing danger for skin and eyes, poisonous).



WARNING!

- Defective accumulators must be disposed in an environmentally friendly way.

Do not throw accumulators in household trash under any circumstances.

Local disposal requirements are to be regarded.

2.8

Maintenance, Service and Malfunctions



DANGER!

Attention – Danger of electric shocks.

Even after switching off the device with the power switch or disconnecting the battery supply, parts of the UPS can produce high voltage.

ATTENTION!

Work on accumulators is only to be conducted and monitored by staff with appropriate knowledge of the required safety rules.

Unauthorised staff are to be kept away from accumulators.

When working on the UPS and the accumulators, the following precautions are to be taken:

- Wristwatches, rings and other metal objects are to be removed,
- Only use tools insulated in accordance with electrotechnical rules.
- Wear protective gear (safety glasses, gloves, face mask, etc.),
- The UPS may not be disassembled.

3. Device Description of UPS

This manual is intended to provide basic information about single-phase offline UPS systems, namely how they function, the application of different functions and what you should do in the event of malfunctioning.

Furthermore, this manual contains instructions for the transport and storage as well as the handling and installation of the UPS system.

The plan guidelines in this manual only relate to special requirements for the UPS systems. During installation, make sure you follow the national and local requirements for electrical installations.

The content of this device description may change due to technological progress. We have tried to present the content correctly and clearly. If, however, we have made errors, we would be grateful for information about this.

We are not liable for errors in this description and the resulting consequences.

The UPS system (uninterruptible power supply system) is intended to protect sensitive, electrical systems such as computers, work stations, electronic cash registers, critical instruments for operation, telecommunication systems, process controls, etc. against interruptions that can occur due to poor power quality or mains failures. Sensitive systems of this kind require complete protection against electrical disturbances. These may involve external disturbances (such as thunderstorms, operational disturbances) or disturbances from adjacent devices (such as engines, air conditioners, processing machines, welding equipment, etc.).

The mains disturbances can be summarised as follows:

- quick and slow mains voltage peaks, fluctuations;
- mains failure;
- quick and slow frequency peaks, fluctuations;
- mains interference or transients

The UPS system monitors the aforementioned mains parameters and protects the connected loads by taking appropriate countermeasures (e.g. switching to support operation in the event of temporary over- or under-voltage in the mains in order to protect the end devices).

3.1 Device Elements on the Front

The front of the device contains all the operating and display elements required for normal operation.

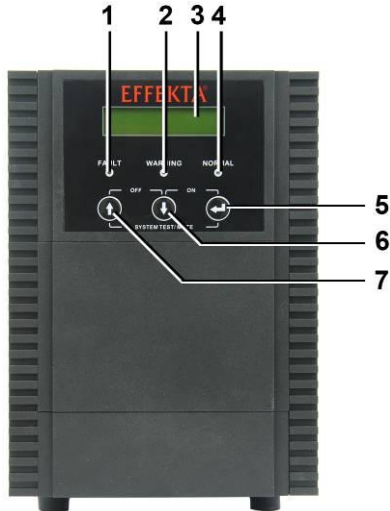

- 1 LED display "FAULT"
- 2 LED display "WARNING"
- 3 LCD display
- 4 LED display "NORMAL"
- 5 Key "Menu selection"
- 6 Key "Menu decrease"
- 7 Key "Menu increase"

Fig. 3-1 - 1 Front view of MTD 700, 1000, 1500, 2000

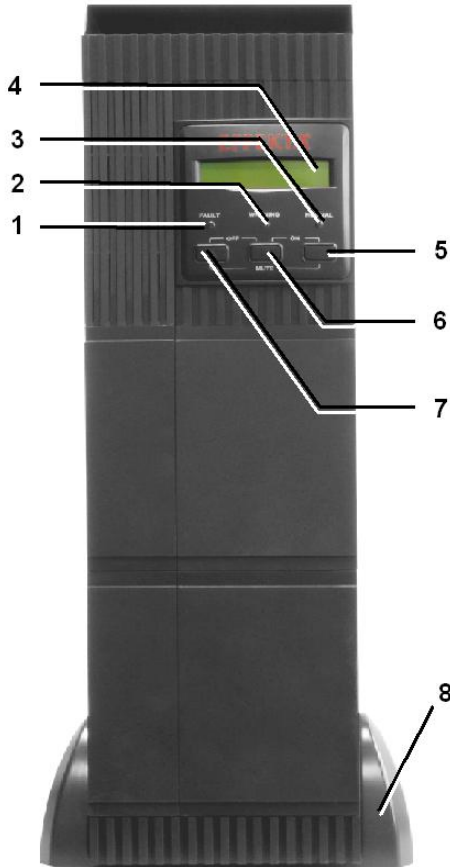

- 1 LED display "FAULT"
- 2 LED display "WARNING"
- 3 LCD display
- 4 LED display "NORMAL"
- 5 Key "Menu selection"
- 6 Key "Menu decrease"
- 7 Key "Menu increase"
- 8 Pedestal

Abb. 3-1 - 2 Front view of MTD 3000



- 1 LCD display
- 2 LED display "FAULT"
- 3 LED display "WARNING"
- 4 LED display "NORMAL"
- 5 Key "LCD"
- 6 Key "POWER ON/OFF"

Fig. 3-1 - 2 Front view of MTD 700RM, 1000RM, 1500RM

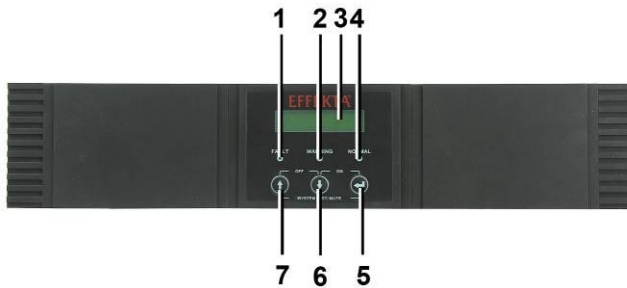

- 1 LED display "FAULT"
- 2 LED display "WARNING"
- 3 LCD display
- 4 LED display "NORMAL"
- 5 Key "Menu selection"
- 6 Key "Menu decrease"
- 7 Key "Menu increase"

Fig. 3-1 - 3 Front view of MTD 2000RM

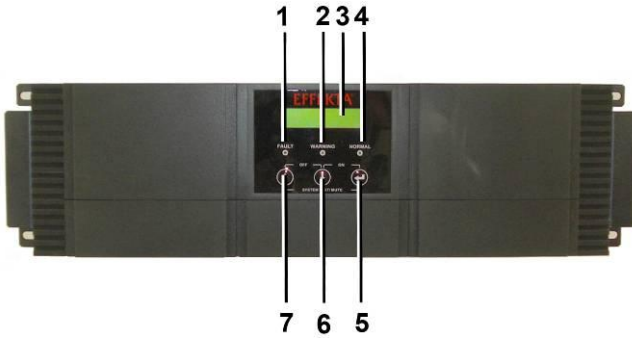

- 1 LED display "FAULT"
- 2 LED display "WARNING"
- 3 LCD display
- 4 LED display "NORMAL"
- 5 Key "Menu selection"
- 6 Key "Menu decrease"
- 7 Key "Menu increase"

Fig. 3-1 - 4 Front view of MTD 3000RM

3.1.1 LCD display

The LCD display is intended to display the type of operation and different status values. The following displays can be selected by pressing the up and down keys:

- Current status
- INPUT VOLTAGE
- OUTPUT VOLTAGE
- INPUT FREQUENCY
- OUTPUT FREQUENCY
- BATTERY VOLTAGE
- BATTERY CAPACITY
- OUTPUT POWER (display of power at the UPS output)
- INSIDE TEMPERATURE (device temperature)
- NEW AC FAIL (new AC failure)
- OLD AC FAIL (old AC failure)
- REC OVERLOAD (AC failure overload)
- VOLT / FREQ SET (output voltage and frequency)
- INPUT (input voltage and frequency)
- OUTPUT (Output voltage and frequency)

3.1.2 LED displays

NORMAL



Flashing: Mains present, UPS switched off (battery charging)
Constant: Mains present, UPS switched on

WARNING



The UPS is in overload or battery operation.

FAULT

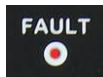

General device error: Malfunction of inverter, over-temperature or battery power is absent.

3.1.3

Keys



Menu selection

The UPS is switched on by simultaneously pressing this key with the menu down key for approx. 3 seconds. The UPS is switched to test operation by simultaneously pressing this key with the menu up key for approx. 3 seconds. In the battery backup mode (mains failure), the acoustic signal provider can be switched off by simultaneously pressing the menu up key.



Menu down (cursor key)

The UPS is switched on by simultaneously pressing this key with the menu selection key for approx. 3 seconds. The UPS is switched off by simultaneously pressing this key with the menu up key for approx. 3 seconds. You can scroll through the menu (display) by pressing the key once.



Menu up (cursor key)

The UPS is switched off by simultaneously pressing this key with the menu up key for approx. 3 seconds. The UPS is switched to test operation by simultaneously pressing this key with the menu selection key for approx. 3 seconds. You can scroll through the menu (display) by pressing the key once.

The device is not started or switched off completely if the "ON/OFF" key combination is not pressed for a sufficiently long time. Where the mains supply is still switched on via the fuse (placed on the back of the UPS), the charging unit also remains active after shutting down the UPS.

3.2 Device Elements on the Back

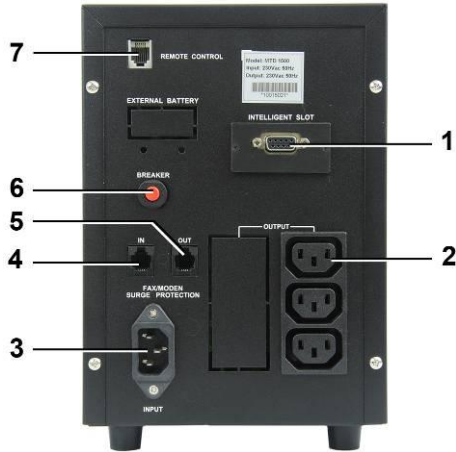

- 1 *Communication interface*
- 2 *UPS output*
- 3 *Mains input*
- 4 *Input over-voltage protection (RJ 45)*
- 5 *Output over-voltage protection (RJ 45)*
- 6 *Circuit breaker for mains input*
- 7 *Connection for remote control*

Fig. 3-2 - 1 Back view of MTD 700, 1000, 1500



- 1 *Communication interface*
- 2 *UPS output*
- 3 *Mains input*
- 4 *Input over-voltage protection (RJ 45)*
- 5 *Output over-voltage protection (RJ 45)*
- 6 *Circuit breaker for mains input*
- 7 *Connection for remote control*

Fig. 3-2 - 2 Back view of MTD 2000

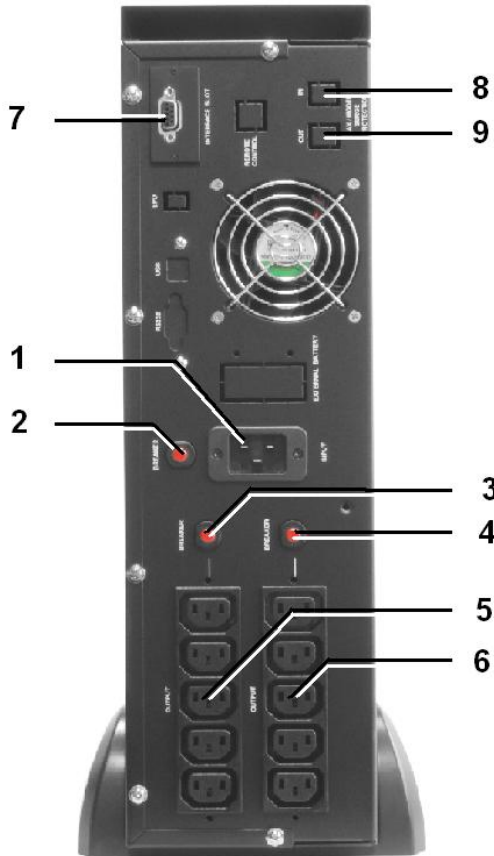

- 1 Mains input
- 2 Circuit breaker for mains input
- 3 Circuit breaker UPS output 1
- 4 Circuit breaker UPS output 2
- 5 UPS output 1 (5 x 10A)
- 6 UPS output 2(5 x 10A)
- 7 Communication interface
- 8 Input over-voltage protection (RJ 45)
- 9 Output over-voltage protection (RJ 45)

Abb. 3-2 - 3 Back view of MTD 3000

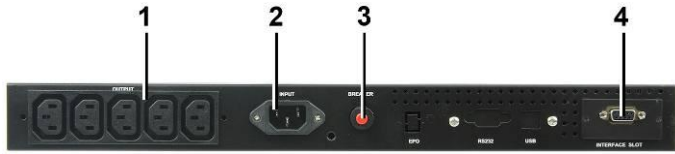

- 1 UPS output
- 2 Mains input
- 3 Circuit breaker for mains input
- 4 Communication interface

Fig. 3-2 - 4 Back view of MTD 700RM, 1000RM, 1500RM

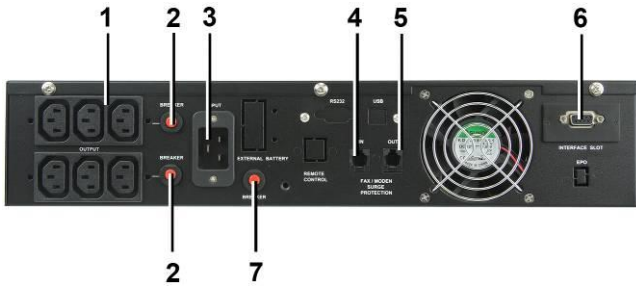

- 1 UPS output
- 2 Circuit breaker for mains output
- 3 Mains input
- 4 Input over-voltage protection (RJ 45)
- 5 Output over-voltage protection (RJ 45)
- 6 Communication interface
- 7 Circuit breaker for mains input

Fig. 3-2 - 5 Back view of MTD 2000RM

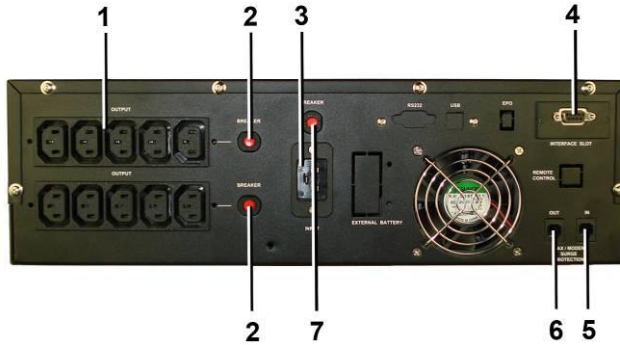

- 1 UPS output
- 2 Circuit breaker for mains output
- 3 Mains input
- 4 Communication interface
- 5 Input over-voltage protection (RJ 45)
- 6 Output over-voltage protection (RJ 45)
- 7 Circuit breaker for mains input

Fig. 3-2 - 6 Back view of MTD 3000RM

DANGER!



All the plug connections on the back (exception: RS232 interface) are on potential mains in the connected state.

Even in an unconnected state, dangerously high voltage on the plug connections can result from the capacities charged within the device.



As soon as the mains input voltage is present, the charging unit is automatically active. Meaning, the internal battery bank is already being charged without the UPS being started.

3.2.1 Remote control

An external display can be connected via the remote connection.

3.2.2 Communication interface

After unscrewing the cover, various expansion cards can be used such as RS232 interface, network adapter, USB interface.

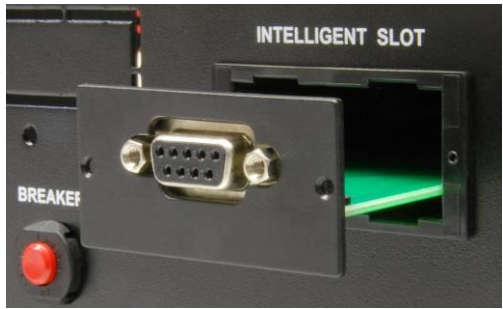

Fig. 3-2 - 7 RS232 interface



Fig. 3-2 - 8 Network connection



Fig. 3-2 - 9 USB interface

3.2.3 UPS output

IEC sockets 10 A and 16 A for the connection of the loads.

DANGER!



The protective conductor must be connected!

Please always regard the indicated input voltage on the identification label or in the technical data of this manual.

3.2.4 Mains input

IEC inlet connector 10 A.

IEC inlet connector 16 A with types 2000RM / 3000RM IEC.

Mains connection via appended connection cable with safety plug.

DANGER!



The protective conductor must be connected!

Please always regard the indicated input voltage on the identification label or in the technical data of this manual.

3.2.5 Input and output over-voltage protection

Over-voltage protection for phone, fax or modem.

3.2.6 Circuit breaker for mains input

In the event of high over-currents or a device defect (e.g. internal short circuit), the circuit breaker switches it off, and the device is thus immediately separated from the connected mains.

3.2.7 Circuit breaker for mains output

In the event of high over-currents or a device defect (e.g. short-circuit of the loads), the circuit breaker switches it off. The load is thus separated from the UPS.

3.3 Acoustic Warnings of the UPS



- Support operation and high battery capacity:
The acoustic warning sounds in the following sequence (A)
[Beep -> long pause (4 sec.) -> Beep -> ..., repeating
(5 times, subsequently no more messages)].



- Support operation and low battery capacity:
- Normal operation and low battery capacity (battery LOW)
- Overload 100 % to 125 %:
The acoustic warning sounds in the following sequence (B)
[Beep -> short pause (1 sec.) -> Beep -> ..., repeating].



- Normal operation and overload of 125 % to 150 %:
The acoustic warning sounds in the following sequence (C)
[Beep -> short pause (0.5 sec.) -> Beep -> ..., repeating].



- Malfunction or overload > 150 %:
The acoustic warning sounds with a continuous tone, sequence (D)
[Beeeeeeeeeeee...p].



- Charging operation: Mains is present, however the UPS is switched off.
The acoustic warning sounds in the following sequence (E)
[Beep -> long pause (2 min.) -> Beep -> ..., repeating].

4. Storage and Unpacking

4.1 Storage of the UPS

If the device is not installed immediately, please consider the following:

- Always store the device and its accessories in the original packaging.
- Recommended surrounding temperatures for storage are:
+ 0 °C ... + 40 °C.
- The device and the packaging are to be protected against moisture.

If the storage period will be longer than 4 months, the UPS and its external battery bank (optional) must be connected with the mains for a period of approx. 8 hours to avoid deep discharge of the accumulators.

4.2 Unpacking the Device

- Remove the shipping cardboard and the packaging material.
- Always hold the device horizontally.
- Check the completeness of the delivery with reference to the delivery note. If the delivery is incomplete or you have received an incorrect delivery, the supplier is to be informed immediately.
- Also check the delivery for transport damage. Complaints about incurred transport damage are to be made immediately:
 - Keep all the shipping cardboard and packaging material for the purpose of the review.
 - Immediately inform the manufacturer or your supplier.
 - Immediately inform the transport company.

5. System Description

The UPS supplies uninterruptible, single-phase voltage for loads that are critical for operation. In addition to supplying the loads, the device also keeps the internal accumulators charged.

In the event of a mains failure or a mains disturbance (e.g. voltage fluctuations), the UPS continues to supply clean voltage at the UPS output without interruption.

The energy is obtained from the accumulator bank in support operation.

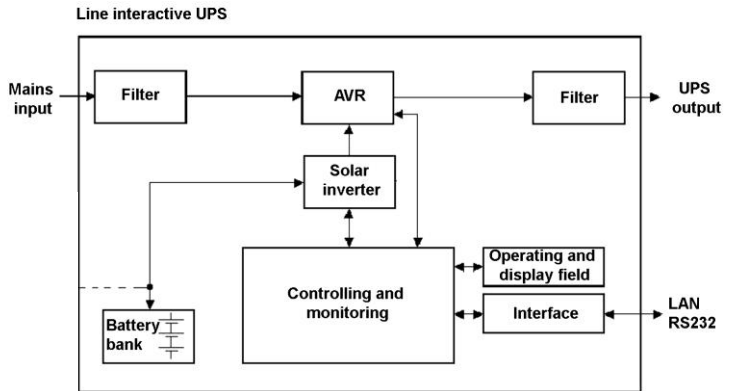

Fig. 5-1 - 1 Schematic diagram of MTD series

The schematic diagram illustrates the individual device modules and roughly shows their interaction.

If the mains failure exceeds the bridging period of the UPS, this switches off to prevent the deep discharge of the battery. With the return of mains voltage, the UPS starts up again automatically, supplies the loads and controls the charging of the battery bank.

Exceptional performance features of the MTD series include:

- short amount of time needed to switch to support operation in the event that the primary mains supply fails;
- real sinusoidal voltage at the output of the UPS, low distortion factor.
- High-performing communication interface (RS232 interface).

6. Installation and Connection of the UPS

All the requirements stated in the technical data for the surrounding and operational conditions are to be observed to ensure the perfect operation of the UPS.

In setting up / installing the UPS, the following must be heeded:

- Avoid extreme temperatures and air moisture.
- Consider the required horizontal installation position.
- Make sure that the ventilation of the device is ensured. An appropriate flow channel is to be considered.
- Pay attention to the arrangement of the system. When installing in super-ordinate systems (e.g. machines, control cabinets), make sure that the UPS is operated in the indicated temperature range. When heat builds up within the installation room, it must be removed with a sufficient ventilator.
- It may only be attached on the flange (floor plate).

6.1 Connection of the UPS

The models of the MTD series are equipped with plug connections.

DANGER!



The UPS system includes components with high voltage and currents. Improper handling can lead to electrical accidents with deadly consequences or property damage.



The protective conductor must be connected! If this is not done, the loads are not earthed.

The connection of the UPS must have the poles correct for generator operation.



If the UPS system is in an emergency power off (EPO) circuit, it is to be considered that the UPS output will not be powerless if the EPO is activated. The loads continue to be supplied for the length of the support period.

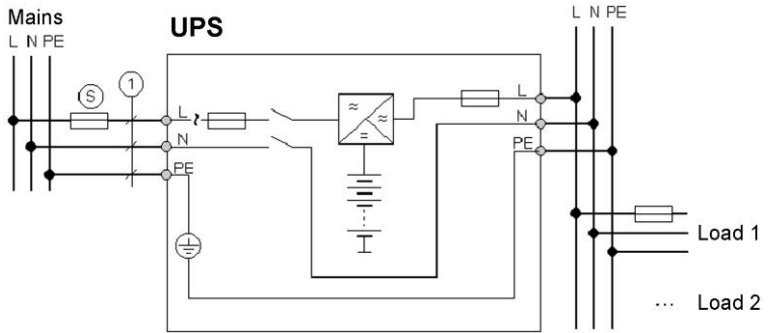

Fig. 6-1 - 1 Connection of the UPS and loads

MTD series	
S:	10 A
1:	0.75 mm ²

MTD 3000	
S:	16 A
1:	1.5 mm ²

6.2 Communication Connection of the UPS

To exchange data with the UPS, a comfortable communication interface is available.

6.2.1 Communication connection RS232

For the connection, only use the connection cable listed in the chapter "Accessories" (1 : 1).

Pin	Assignment	
2	RS232	Receiving circuit Rx or shutdown SD
3	RS232	Transmission line Tx
5	RS232	GND



The communication interface is completely galvanically isolated.



The UPS can also be forced to shut down immediately via the serial interface RS232 during support operation. This is triggered by a permanent + 12 V signal on the Rx receiving circuit ("shut down" - function).

6.2.2 Communication connection USB

An option is to equip the UPS with a USB communication interface.

6.2.3 Communication connection SNMP

An option is to equip the UPS with a SNMP communication interface.

6.2.4 Relay card

An option is to equip the UPS with a relay card.

6.3 Connection Sequence

Connect the UPS with the mains, and make sure the mains and the UPS are shut off during the process.

Before the loads are connected on the output, the basic configuration must be set.

Connect the load(s) with the UPS. Make sure that all loads are switched off.

7. The Device and its Operation

7.1 Operating the UPS

The operation of this system is characterised by various types of operations and messages.

7.1.1 Types of operation and messages

Charging operation

If the mains is present and the input fuse is switched on, the UPS is in the charging operation.

-> The accumulators are already charged, **the UPS has not yet started.**

Depending on the basic settings, there is no output voltage or the UPS is in the inverter mode and there is output voltage.

Display/warning:

The green LED (NORMAL) blinks and an acoustic warning sounds in the sequence (E)

(Beep -> long pause (2 min.) -> Beep -> ..., repeating).

No
output voltage:



```
AC:OK    BAT:OK  
PRESS TURN ON
```

With
output voltage:



```
AC:OK    BAT:OK  
LINE MODE
```

Start operation

If the mains is present, the start process begins after pressing the two ON keys for 3 seconds. Afterwards, the UPS switches to bypass operation for approximately 10 seconds. Then the mains operation is automatically activated. If no mains was present during the start process, the UPS switches directly to support operation after the start process.

Only the key "POWER ON/OFF" is pressed for 3 seconds with the types 1000RM and 1500RM.

Display/warning:

The yellow LED (WARNING) lights up during the bypass operation; the acoustic warning sounds 2 x briefly.

Bypass operation

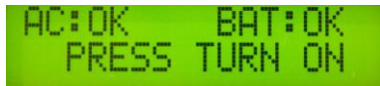

Mains operation

If the mains is present and if the UPS has completely finished the start process, the UPS is automatically in mains operation.

-> In this type of operation, the battery bank is charged in accordance with need.

Display/warning:

Only the green LED (NORMAL) blinks constantly, no acoustic warning.

Mains operation:



Support operation

If the mains fails, the UPS immediately switches to support operation.

Display/warning:

The yellow LED (WARNING) lights up.

The acoustic warning sounds in the sequence (A);

(Beep -> long pause (4 sec.) -> Beep -> ..., repeating).

If the battery falls below the limit of battery low, the warning sounds in the following sequence (B);

(Beep -> short pause (1 sec.) -> Beep -> ..., repeating).

Battery operation



Test operation

No test operation is possible for the types 1000RM and 1500RM.

If the UPS is in mains operation, you can switch to test operation by simultaneously pressing, for approx. 3 seconds, the key "Menu selection" and the key "Menu up." This switches to support operation for approx. 10 sec.

Display/warning:

- red LED (FAULT)
- yellow LED (WARNING)
- green LED (NORMAL).

Display "BAT INVERTER" and yellow LED (WARNING) for approx. 10 sec.

No acoustic warning.



AC:OK BAT:OK
TESTING

Overload operation

If an overload is present at the UPS output, the UPS switches, independently of the overload, to the inverter mode after a maximum of 30 seconds. You can switch to the load display by pressing the key "Menu down."

Display/warning before switching:

The green LED (NORMAL) **and** the yellow LED (WARNING) light up;

The acoustic warning sounds in the sequence (A);

(Beep -> long pause (4 sec.) -> Beep -> ..., repeating).

Display/warning after switching to inverter mode:

Only the yellow LED (WARNING) lights up; the acoustic warning sounds in a continuous tone sequence (D).



BATTERY CAPACITY
100 %

Faulty operation

If there is a device error, the UPS immediately switches to the inverter mode. The error operation can be triggered by overload, short circuit on the UPS output, over-temperature, inverter error or DC/BUS error.

Display/warning in the inverter mode:
 An overload causes the yellow LED (WARNING) to light up;
 Over-temperature, inverter or DC/BUS errors cause the red LED (FAULT) to light up;
 The acoustic warning sounds sequence (D) in a continuous tone.

Inverter mode	AC:FAIL BAT:OK INVERTER MODE
---------------	---------------------------------







7.1.2

Display of measurement readings

For the types 1000RM and 1500RM you can switch the display via the key "LCD." Since there is only one key, this is only possible in one direction.

You can switch to the following displays with the keys "Menu down" and "Menu up":

INPUT VOLTAGE	INPUT VOLTAGE 235 VAC
OUTPUT VOLTAGE	OUTPUT VOLTAGE 237 VAC
INPUT FREQUENCY	INPUT FREQUENCY 50 HZ
OUTPUT FREQUENCY	OUTPUT FREQUENCY 50 HZ
BATTERY VOLTAGE	BATTERY VOLTAGE 40 VDC
BATTERY CAPACITY	BATTERY CAPACITY 100 %

<p>OUTPUT POWER</p>	
<p>INSIDE TEMP (inside temperature)</p>	
<p>NEW AC FAIL (new AC failure)</p>	
<p>OLD AC FAIL (old AC failure)</p>	
<p>VOLT / FREQ SET</p>	
<p>INPUT /OUTPUT</p>	

7.2 Operating Manual for the UPS

WARNING!



The operator of this UPS system must always observe the instructions in this manual. The operator may only undertake the following listed measures and only with particular care:

- Using the operating elements: switch on, start and switch off the UPS.
- Reading the display elements and interpreting the acoustic warnings.
- Starting the test operation.
- Using the communication interface, whereby the connection to a computer or other systems must already be present with UPS equipment that have a permanent connection.

The extensive protective functions that the UPS system performs with regard to the load(s) means that the UPS works completely automatically. Only the switching on and starting or switching off is done by the operator. Furthermore, a data exchange can take place via the communication interface and/or the SNMP adapter, although this is not absolutely necessary for general operation of the system.

7.2.1 Switching on and starting the UPS

To switch on the UPS, connect the UPS with the supply mains by inserting the power cable.

Make sure that the mains fuse (back of the device) is inserted. Before initially starting the UPS, the basic settings must be checked.

The UPS is started by simultaneously pressing both the key "Menu selection" and "Menu down" (hold down for approx. 3 sec.). Press the "POWER ON/OFF" key for approx. 3 sec. for the types 1000RM - 1500RM.

After finishing the start procedure, the UPS reaches the appropriate type of operation.

7.2.2 Shutting and switching off the UPS

With a running UPS, it is shut off by simultaneously pressing both the keys "Menu down" and "Menu up" (hold down for approx. 3 sec.). Press the "POWER ON/OFF" key for approx. 3 sec. with the types 1000RM / 1500RM.

The UPS remains in the charging operation mode to keep the accumulators charged and ready for operation. To completely switch off the UPS system, the device must be unplugged by separating the power cable from the mains.

7.2.3 Changing the basic settings

WARNING!



Before you change the basic settings, you should consider the following points:

- False settings can cause damage to the UPS and the load.
 - Inform yourself about the technical data of the connected loads.
 - Separate all loads from the load output.
 - Make sure that the UPS is in the switched-off operating mode.
 - The new settings are only adopted after a complete restart (switch off; pull mains plug until system stops; reinsert mains plug).
-

Basic settings

The changing of these parameters is not possible for types 1000RM / 1500RM.

The following parameters can be changed via the basic settings:

- output voltage (220 V, 230 V, 240 V AC).
- output frequency (50 Hz, 60 Hz) in support operation; the input frequency must be adjusted.

Scroll with the key "Menu down" in a switched-off state to the display INVERTER MODE. The cursor can now be set to LO or HI with the key "Menu selection." The voltage threshold for the inverter mode can be changed via the keys "Menu down" and "Menu up."

Scroll with the key "Menu down" in a switched-off state to the display VOLT/FREQ SET. The cursor can now be set to Vac (output voltage) or Hz (output frequency) with the key "Menu selection." The output voltage or the output frequency, in the switched-off state, can be changed via the keys "Menu down" and "Menu up."

The output frequency can have the following settings:

- 50 Hz -> Output frequency 50 Hz
- 60 Hz -> Output frequency 60 Hz

Confirm the entry with the key "Menu selection."

7.2.4 Starting the test operation

This function is not present for the types 1000RM / 1500RM.

WARNING!



Before you start the test operation, you should consider the following points:

- Inform involved employees of your action.
 - For the sake of caution, please make a backup copy of all the data of the connected loads.
 - Leave all the loads turned on so that the load behaviour remains.
 - Make sure that the UPS is in the mains operating mode.
 - Press both the key "Menu selection" and "Menu up" for 3 sec. to switch to test operation.
-



Such action in this operating mode is only a function test of the UPS. The display of the battery capacity is only a measurement of the charged state of the battery bank at this moment. A statement about the overall capacity of the battery bank or the connected total support period cannot be derived from this.

7.2.5 Communication

Appropriate software packages are necessary for the exchange of data between the UPS and a superordinate system. Please see the service spectrum in the chapter "Software."

8. Starting up the UPS System

To ensure error-free start-up, the following points are to be observed:

1. Connect the UPS, with the provided connection cable, to the mains.
2. Wait until the system test has been concluded.
3. Switch on the UPS by pressing the previously described key combination (or "POWER ON/OFF").
4. Wait until the UPS is in the mains operating mode.
5. Now switch on the loads successively and observe the load display.



If all the steps have been completed successfully, the UPS must be in the mains operation mode and the load display should amount to less than 100 %.

6. Now switch off the system (key combination "OFF" or "POWER ON/OFF").
7. Please wait a few seconds ("refresh").
8. Start the UPS again.



The UPS system should again be in the mains operating mode after the indicated length of 10 sec. This test ensures that the systems will also start with the connected total load.

The system can now remain ready for operation in this state.

9. Eliminating Errors



WARNING!

Only authorised professional staff are to perform work for eliminating errors on the UPS system.

Problem	Possible cause	Remedy
No function, no display, no warning.	The mains is not present or not switched on for the UPS.	Make sure that all the cables are connected and confirm this through the appropriate voltage measurements. Switch on the circuit breaker of the UPS.
The UPS cannot be started, no warning.	The ON key was not pressed long enough.	Press the ON key for a length of approx. 2 - 3 sec.
The UPS is in bypass operation, the "Fault" LED lights up, the display shows "Overload fault," an acoustic warning sounds.	The UPS is overloaded on the load side.	Separate the loads or a portion of the loads from the UPS until the load display $\leq 100\%$ is showed.
The UPS is in bypass operation, the "Fault" LED lights up, the display shows "Temp. fault," an acoustic warning sounds.	The UPS has overheated.	Shut down the UPS, remove the connected loads and inform our service team.

Problem	Possible cause	Remedy
The UPS is in bypass operation, the "Fault" LED lights up, the display shows "Inverter fault," an acoustic warning sounds.	The solar inverter does not work.	Shut down the UPS, remove the connected loads and inform our service team.
The UPS is in bypass operation, the "Fault" LED lights up, the display shows "DC_BUS fault," an acoustic warning sounds.	The DC link of the UPS does not work correctly.	Shut down the UPS, remove the connected users and inform our service team.
The bridging period is shorter than the nominal value.	The accumulators are not completely charged or individual accumulators are defective.	Charge the accumulators for more than 8 hours and repeat the test. If the problem continues, the accumulators are to be replaced.
The UPS appears OK, the loads do not work.	The connection between the UPS and the loads is defective.	Check the connection and confirm this by a voltage measurement.

If the UPS error you have observed cannot be found in the table, please inform our service team and have the following information at your disposal:

1. Model number, serial number
2. Date on which the problem occurred
3. Detailed description of the problem

10. Software

A suitable software package can determine and process the settings and the operating states of the UPS via the communication interface.

The software packages are available from the manufacturer / dealer or under the provided service hotline. You will receive useful information about the suited software packages with regard to your application and the UPS.

For more on this, you can also visit our website:

<http://www.effekta.com/>

The following basic functions are supported by all software packages:

- identifying and displaying the mains state of the UPS
- displaying the UPS output state
- identifying and displaying the charged state of the battery bank
- closing open applications in the event of a mains failure
- shutting down the operating system
- generating report files
- general monitoring of UPS data and states (diagnosis function).

You will find more information about the individual software packages such as installation, operation and service spectrum in the software manual.



In the chapter "Scope of Delivery / (Optional) Accessories" you will find a suitable and tested software package.

11. Maintenance and Service

You can assume a long service life and uninterrupted operation with minimum maintenance for your UPS system.

The reliability of the UPS will however be determined primarily by the surrounding conditions. Temperature and moisture in the surroundings of the system must be kept within the limits. Furthermore, the area around the UPS should be as clean and free of dust as possible.

With an ideal surrounding temperature of 22 °C, the typical service life of the accumulators amounts to approximately 4 years. By using special accumulators, the service life can be significantly increased (approx. 8 - 10 years).

At regular intervals (6 - 12 months), you should check that the remaining bridging period is sufficient for the intended purposes. If this is not the case, the accumulators must be exchanged.

11.1 Measurement of the Bridging Period (Support Period)

WARNING!



Before you begin with this procedure, you should be sure to make a backup of all open data records. Also inform all involved employees.

To measure the support length, there are primarily two methods.

Method a)

is suited for measuring the actual support period, whereby the loads will inevitably become powerless at the end of the bridging period.

Method b)

permits the determination of the remaining capacity after a defined support period. In the process, the loads usually do not become powerless.

To apply one of the named methods, force the UPS into support operation by simulating a mains failure (e.g. trigger building's security system). Do not remove the power cables under any circumstances, since then the protective conductor is separated. After completing the measurement, switch on the circuit breaker again and start the UPS as usual with the ON key.



Remember that the accumulators of the system are discharged after the measurement, which means that the UPS system must work for a few hours (at least 5 hours) in the mains and charging operation before it is ready for use again at approx. 80 %.

If the measurement of the support period is not carried out due to local conditions or directives, we recommend a prophylactic replacement of the accumulators every two years to avoid the risk of an insufficient support period on account of degenerated accumulators.

11.2 Replacing the Accumulators

DANGER!



Before you begin with this procedure, please regard the listed safety instructions. Carry out the work in the stated sequence. Be sure to use safety tools. Before beginning work, make sure that the UPS is switched off and separated from the supply mains.

Only professional staff may perform work on the accumulator bank. They must be specially trained in the handling of accumulators.



It must be considered that high voltage is still present in a shut-off device. This includes e.g. the voltage of the accumulator bank, charging voltage of mains capacitors. Appropriate safety measures are to be taken against electrical shocks.

In this manual, the replacement of accumulators is not described in more detail due to the aforementioned dangers.

For appropriate professional staff, a separate description is available upon request.

11.3 Service Report

Always enter all the maintenance and service work that has been performed on the UPS system in the service report.

Date	Executed work	Performed by

11.4 Service Hotline

Should problems with the UPS arise against expectations or if you need safety-relevant information, please contact our service hotline under the phone or fax number:

Phone no.: 0049 / (0) 741 – 17451-52

Fax no.: 0049 / (0) 741 – 17451-29

Should it not be possible to call by phone, we have created an e-mail contact for you:

ups@effekta.com.

You can also directly contact the area or branch important for you at the following internet address.

<http://www.effekta.com/html/kontakt.html>

11.5 Maintenance and Service Contracts

EFFEKTA Regeltechnik GmbH offers you appropriate maintenance and other services to ensure the greatest possible reliability and availability of the UPS system. We can also support and help you in the following areas with our professional staff as part of a maintenance contract:



Regular review of the systems, especially the accumulators, as well as a prompt exchange and disposal of the accumulators.



Review of the UPS installation.



Disposal of defective or degenerated components.

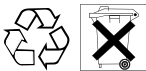

Environmentally-friendly disposal of the accumulators.

You will find the entire spectrum of our services at:

<http://www.effekta.com/html/service.html>

or contact us directly under the aforementioned addresses.

12. Technical Data

12.1 Device Specifications for Tower Housing

MTD model		700	1000	1500	2000	3000
Power	Power in VA	700	1000	1500	2000	3000
	Power in W	438	625	938	1250	1875
Bridging period	Nominal load	8 min	6 min	6 min	4 min	3 min
Input	Nominal voltage	230 V AC				
	Input voltage area	170~ 300 VAC				
	Input frequency area	45~ 70 Hz Auto-sensing				
	Boost start threshold / shut down	195.5 VAC ± 2 % / 205.5 V AC ± 2 %				
	Boost start threshold / shut down	264.5 VAC ± 2 % / 254.5 V AC ± 2 %				
	Under-voltage warning threshold/ All clear	170 VAC ± 2 % / 180 V AC ± 2 %				
	Over-voltage warning threshold / All clear	300 VAC ± 2 % / 290 VAC ± 2 %				
Output	Output voltage	Can be set on the LCD display to 220, 230, 240 V AC				
	Voltage tolerance	Line mode ± 15 %, Battery mode < 3 % RMS				
	Frequency tolerance	Line mode 50 Hz or 60 Hz, Battery mode ± 0.1 Hz				
	Power factor	0.625				
	Voltage form	Sinusoidal				
	Efficiency	> 80 %				
DC start	Cold start	Yes				
Switching time	Typical	< 4 msec.				
Battery	Nominal voltage	24 VDC		36 VDC		
	Number of blocks x Nominal capacity / Block	2 x 7 Ah		3 x 7 Ah	3 x 9 Ah	6 x 7 Ah
	Type	Closed, maintenance-free VRLA batteries				
	Life expectancy	approx. 5 years (depending on the environmental conditions) option for 10 years				
	Charging time	approx. 5 hours to 90 %				

MTD model		700	1000	1500	2000	3000
Display	LCD	UPS type, UPS status, in-/output voltage/ frequency, load, battery- volt. / capacity, temp.				
	LED	Normal (green) / Warning (orange) / Fault (red)				
Acoustic alarm	Battery operation	Sound every 4 seconds				
	Battery low	Sound every second				
	UPS malfunction	Uninterrupted sound				
	Overload	Sound 2x per second				
Interfaces	Card slot	Equipped with RS 232 interface in standard version. Optionally available cards: USB, Relay AS400, SNMP, optocoupler				
Environmental conditions	Temperature	0 °C – 40 °C				
	Humidity	0 – 95 % not condensing				
	Operation height	< 2000 m above sea level				
	Noise during operation	< 55 dBA @ 1 m				
Mechanical	Housing	Steel plate tower / plastic front				
	Protective class	IP 20				
	Dimensions (H x W x D in mm)	210 x 145 x 380	210 x 145 x 445			470 x 195 x 475
	Weight	16.5 kg	17,5 kg	22.5 kg	37 kg	
Connections	Input	1 x IEC (10 A)				1 x IEC (16A)
	Output	3 x IEC	6 x IEC		10 x IEC	
Standards	LVD	EN 62040-1-1:2003				
	EMC	EN 62040-2:2006				

12.2 Device Specifications for Rack Mountable



MTD model		700RM	1000RM	1500RM	2000RM	3000RM
Power	Power in VA	700	1000	1500	2000	3000
	Power in W	438	625	938	1250	1875
Bridging period	Nominal load	4 min	3 min	2 min	4 min	3 min
Input	Nominal voltage	230 V AC				
	Input voltage area	170~ 300 VAC				
	Input frequency area	45~ 70 Hz Auto-sensing				
	Boost start threshold / shut down	195.5 VAC \pm 2 % / 205.5 V AC \pm 2 %				
	Boost start threshold / shut down	264.5 VAC \pm 2 % / 254.5 V AC \pm 2 %				
	Under-voltage warning threshold / All clear	170 VAC \pm 2 % / 180 V AC \pm 2 %				
	Over-voltage warning threshold / All clear	300 VAC \pm 2 % / 290 VAC \pm 2 %				
Output	Output voltage	Can be set on the LCD display to 220, 230, 240 V AC				
	Voltage tolerance	Line mode \pm 15 %, Battery mode < 3 % RMS				
	Frequency tolerance	Line mode 50 Hz or 60 Hz, Battery mode \pm 0.1 Hz				
	Power factor	0.625				
	Voltage form	Sinusoidal				
	Efficiency	> 80 %				
DC start	Cold start	Yes				
Switching time	Typical	< 4 msec.				
Battery	Nominal voltage	24 VDC			36 VDC	
	Number of blocks x Nominal capacity / Block	4 x 6V/ 7Ah			3 x 9 Ah	6 x 7 Ah
	Type	Closed, maintenance-free VRLA batteries				
	Life expectancy	approx. 5 years (depending on the environmental conditions) option for 10 years				
	Charging time	approx. 5 hours to 90 %				

Model		700 RM	1000 RM	1500 RM	2000 RM	3000 RM
Display	LCD	UPS type, UPS status, in-/output voltage/ frequency, load, batt. volt. / capacity, temp.				
	LED	Normal (green) / Warning (orange) / Fault (red)				
Acoustic alarm	Battery operation	Sound every 4 seconds				
	Battery low	Sound every second				
	UPS malfunction	Uninterrupted sound				
	Overload	Sound 2 x per second				
Interfaces	Card slot	Equipped with RS 232 interface in standard version. Optionally available cards: USB, Relay AS400, SNMP, Modbus				
Environmental conditions	Temperature	0 °C – 40 °C				
	Humidity	0 – 95 % not condensing				
	Operation height	< 2000 m above sea level				
	Noise during operation	< 55 dBA @ 1 m				
Mechanical	Housing	Steel plate tower / plastic front				
	Protective class	IP 20				
	Dimensions (H x W x D)	1 HE x 19" x 515 mm			2 HE x 19" x 465 mm	3HE x 19"x 465 mm
	Weight	18.0 kg	20,5 kg	24,5 kg	36,9 kg	
3Connections	Input	1 x IEC (10 A)			1 x IEC (16 A)	
	Output	5 x IEC			6 x IEC	10x IEC
Standards	LVD	EN 62040-1-1:2003				
	EMC	EN 62040-2:2006				

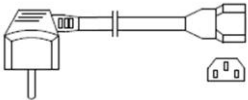

12.3 Scope of Delivery / (Optional) Accessories

In the following, you will find a list of components that are specially approved and tested by **EFFEKTA Regeltechnik GmbH** for this UPS (please check the completeness of the delivery immediately after receiving the goods).

12.3.1 Scope of delivery MTD 700, 1000, 1500, 2000, 3000

Units	Description	Function / View:	Article no.	Scope of delivery
1 x	UPS electronics incl. internal batteries		MTD 700: ACX 11MSS70000000 MTD 1000: ACX 11MSS1K000000 MTD 1500: ACX 11MSS1K000000 MTD 2000: ACX 11MSS2K000000 MTD 3000: ACX 11MSS3K000000	X
1 x	Operating manual	Printed manual - English	ZBBSKHMTDSEREE31	X
1 x	Software package "PowerShut Plus"	CD-ROM mains-enabled shut-down and diagnosis software 1 licence for Windows/Novell 1 licence for UNIX, LINUX, MAC 1 licence for RCCMD (network remote client)	SWSKLANPOWSHXXXX	X
1 x	LAN/RS232 connection	Interface connection cable	WSSSKRSR2321M800	X
1 x	Connection cable (IEC 10 A straight) 2000RM/3000 RM (IEC 16 A straight)		WSPSKSK10AG1M600 WSPSKSK16AG1M600	X
1 x	Output cable (IEC 10 A straight)		WSPSKKK10AG1M500	X
	For MTD 3000 to Tower	Cover up Plastic bracket (Pedestal)	ZBBSKMMT3KTSTF00 ZBBSKMMT3KTLLA00	x

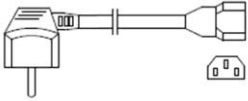
12.3.2 Scope of delivery for MTD 1000RM, 1500RM, 2000RM, 3000RM

Units	Description	Function / View:	Article no.	Scope of delivery
1 x	UPS electronics incl. internal batteries		MTD 700RM ACX11USR70000000 MTD 1000RM: ACX11MSR1K000000 MTD 1500RM: ACX11MSR1K500000 MTD 2000RM: ACX11MSR2K000000 MTD 3000RM: ACX11MSR3K000000	X
1 x	Operating manual	Printed manual - English	ZBBSKHMTDSEREE31	X
1 x	Software package "PowerShut Plus"	CD-ROM mains-enabled shut-down and diagnosis software 1 licence for Windows/Novell 1 licence for UNIX, LINUX, MAC 1 licence for RCCMD (network remote client)	SWSKLANPOWSHXXXX	X
1 x	LAN/RS232 connection	Interface connection cable	WSSSKSRS2321M800	X
1 x	Connection cable (IEC 10 A straight) MTD 2000RM (IEC 16 A straight)		WSPSKSK10AG1M600 WSPSKSK16AG1M600	X
1 x	Output cable (IEC 10 A straight)		WSPSKKK10AG1M500	X
2x 8x	Mounting brackets Screws each rack		ZBBSKMMT3KRB1900	X

12.3.3 Communication interfaces / (optional accessories)

Description	Article number
USB plug-in card	ZOP/USB
Relay plug-in card	ZOP/AS400
Optocoupler plug-in card	ZOP/DB9
SNMP mini slot plug-in card	GE/32CS121MINI

12.4 Wear Parts List

The components listed in the following are subject to normal aging and are not covered by the warranty for this UPS:

Wear part	Function	Article number
XXXX XX XX ** Accumulator (battery) 12 V xx Ah	Energy storage	Depending on the mounting, see accessories or request information

** You will find the wear part description of the battery in the mounted accumulators or upon request.

13. Requirements from the Declaration of Conformity

The CE-labelled UPS to the following EU directives and harmonised standards:

EU directives: LVD 2006/95/EC
EMC 2004/108/EC

Harmonised standards: EN 62040-1-1:2003
EN 62040-2:2006

You can receive an EU declaration of conformity for products with a CE label upon request at the following address:



EFFEKTA Regeltechnik GmbH

Rheinwaldstr. 34
78628 Rottweil

Phone no.: 0049 / (0) 741 –17451-0

Notes

Notes

Notes

EFFEKTA[®]

EFFEKTA Regeltechnik GmbH

Rheinwaldstraße 34

D – 78628 Rottweil